

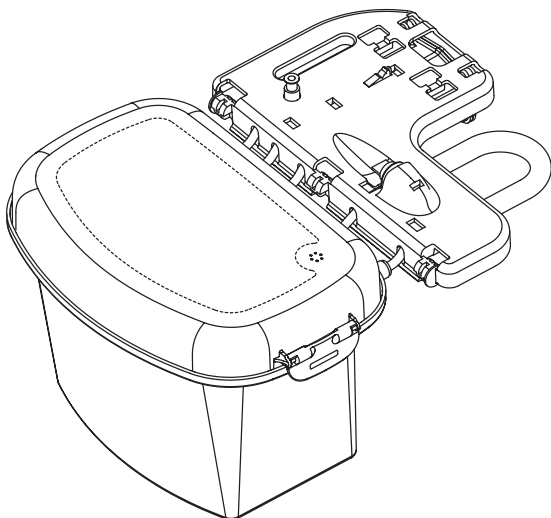

Organ Recovery systems

LifePort[®] Kidney Transporter Disposable Perfusion Circuit



Instructions for Use

LifePort Kidney Transporter Disposable Perfusion Circuit is for use only with LifePort Kidney Transporter system.

 **Organ Recovery Systems, Inc**
One Pierce Place, Suite 475W
Itasca, IL 60143
USA

T +1.847.824.2600
F +1.847.824.0234
Perfusion Helpline
+1.866.682.4800

Organ Recovery Systems NV
Da Vincilaan 2, Box 6
1831 Diegem
Belgium

T +32.2.715.0000
F +32.2.715.0009
Perfusion Helpline
+32.2.715.0005

ORS Representacoes do Brasil Ltda.
170 Moema Avenue, Suite 11 & 12
Sao Paulo, SP 04077-020
Brazil

T +55.11.3586.6259
F +55.11.3586.4944
Perfusion Helpline
+55.11.98638.0086

LKT201

Instructions for Use printed in:



INDICATIONS FOR USE

LifePort Kidney Transporter (LKT) system is intended to be used for the continuous hypothermic machine perfusion of kidneys for the preservation, transportation and eventual transplantation into a recipient.

DEVICE DESCRIPTION

LifePort Kidney Transporter Disposable Perfusion Circuit is used to contain the kidney and perfusate under aseptic conditions during transport.

The complete LifePort Kidney Transporter system is comprised of the following components:

- LifePort Kidney Transporter (LKT100P/LKT101P)
- LifePort Kidney Transporter Disposable Perfusion Circuit (LKT201)
- LifePort Kidney Transporter Disposable Sterile Drape (LKT300)
- LifePort Kidney Transporter Disposable Cannula (CAN/UCAN)

INSTRUCTIONS FOR USE

Prepare LifePort Kidney Transporter as described in the LifePort Kidney Transporter Operator's Manual. Prepare KPS-1®, Kidney Perfusion Solution in accordance to the Instructions for Use. Maintain perfusate at appropriate temperature, approximately 2-8°C.



CAUTION: Where noted, perform the following procedure on an aseptic field using aseptic technique.

1. *Using standard aseptic technique*, prepare a sterile field on a work table and introduce all necessary materials.
2. *Using standard aseptic technique*, remove Outer Perfusion Circuit Lid and Inner Perfusion Circuit Lid and place onto the sterile field.
3. *Using standard aseptic technique*, remove the Kidney Cradle and set aside within the sterile field.
4. *Using standard aseptic technique*, fill LifePort Kidney Transporter Disposable Perfusion Circuit with 1 Liter chilled (2-8°C) perfusate.
5. *Using standard aseptic technique*, replace and secure Inner Perfusion Circuit Lid followed by the Outer Perfusion Circuit Lid.



CAUTION: LifePort Kidney Transporter Disposable Perfusion Circuit inner surfaces are considered sterile, while outer surfaces are not considered sterile.

6. Place LifePort Kidney Transporter Disposable Perfusion Circuit into LifePort Kidney Transporter.
7. Position the Tubeframe upright, perpendicular to the Pump Deck. Insert the hinges into the receivers before rotating flat onto the Pump Deck.
8. Open the Pumphead Raceway and stretch the Pump Tubing Loop around the Infusion Pump. Close and latch the Pumphead Raceway.
9. Rotate the Pump Deck Locking Arm 90 degrees until it clicks into place.
10. Connect the Pressure Sensor Cable from the Pump Deck to the Pressure Sensor Connector on the Tubeframe.



NOTE: Follow the procedure outlined in the LifePort Kidney Transporter Disposable Sterile Drape Instructions for Use to maintain aseptic conditions.



NOTE: Follow the procedure outlined in the LifePort Kidney Transporter Disposable Cannula Instructions for Use to cannulate and secure the kidney.

11. *Using standard aseptic technique*, transfer the cannulated kidney in the Kidney Cradle to LifePort Kidney Transporter, being careful to avoid catching the Infuse Line.



NOTE: Follow the procedure in the LifePort Kidney Transporter Operator's Manual to start the perfusion process and check for leaks.

12. *Using standard aseptic technique*, replace and secure Inner Perfusion Circuit Lid.



NOTE: Follow the procedure in the LifePort Kidney Transporter Disposable Sterile Drape Instructions for Use for removal from LifePort Kidney Transporter.

13. Replace and secure Outer Perfusion Circuit Lid.









NOTE: Follow the procedure in the LifePort Kidney Transporter Operator's Manual to continue the perfusion process.

Storage Conditions: Store between 2°C and 40°C. Avoid excessive heat and humidity. Keep dry and keep away from direct sunlight. Sterile unless package is damaged or open.















Technical Assistance: Please contact Organ Recovery Systems 24/7 Perfusion Helpline at +866.682.4800 (toll free in US), +32.2.715.0005 (Belgium), 0800.940.0057 (Brazil), +33.967.23.00.16 (France), or +34.910.91.16.16 (Spain).

Contraindications: There are no known contraindications when used as directed.

WARNINGS AND CAUTIONS

-
-  **CAUTION:** Federal (USA) law restricts this device to sale by or on the order of a physician.
-
-  **CAUTION:** LifePort Kidney Transporter Disposable Products should be stored indoors in a dry location out of direct sunlight.
-
-  **WARNING:** Visually check LifePort Kidney Transporter Disposable Products. Do not use if parts are loose, cracked, broken, or liquid is leaking. Check that all fittings are tight before installation.
-
-  **WARNING:** For single use only. Do not reuse, reprocess or resterilize. Reusing, reprocessing, or reesterilization of single-use devices creates a potential risk of patient or user infections due to contamination. This contamination may lead to injury, illness, or other serious patient complications.
-
-  **WARNING:** Use standard aseptic technique and universal precautions (e.g., gloves, masks, gowns, goggles or equivalent eye protection, biohazard bags) when handling the kidney, and when handling and disposing of LifePort Kidney Transporter Disposable Products and perfusate to prevent the possible transmission of pathogens to medical personnel and patients. The single practitioner, working alone must pay special attention to maintain these conditions.
-
-  **WARNING:** Before the operator begins to apply the LifePort Kidney Transporter Disposable Sterile Drape, the Outer Perfusion Circuit Lid should be removed. The exterior surfaces of the Outer Perfusion Circuit Lid are not considered part of a sterile field. Use standard aseptic technique when handling the interior surface.
-

EXPLANATION OF SYMBOLS

	Warning/Caution		Use By, YYYY-MM-DD		Temperature Limits
	Lot Number		Date of Manufacture, YYYY-MM-DD		Consult Instruction for Use
	Reference Number		Manufacturer		Keep Away From Sunlight
	Do Not Reuse		Do Not Resterilize		Keep Dry
	Sterile Medical Devices Using Ethylene Oxide				Prescription Medical Device

INDICAÇÕES DE USO

O sistema LifePort Kidney Transporter (LKT) é indicado para a perfusão hipotérmica contínua por máquina para a preservação, o transporte e o eventual transplante de um rim em um receptor.

DESCRIÇÃO DO APARELHO

O Circuito de Perfusão Descartável da LifePort Kidney Transporter é utilizado para manter o rim e o líquido de perfusão sob condições assépticas durante o transporte.

O sistema completo da LifePort Kidney Transporter é composto dos seguintes itens:

- LifePort Kidney Transporter (LKT100P/LKT101P)
- Circuito de Perfusão Descartável da LifePort Kidney Transporter (LKT201)
- Campo Cirúrgico Estéril Descartável da LifePort Kidney Transporter (LKT300)
- Cânula Descartável da LifePort Kidney Transporter (CAN/UCAN)

INSTRUÇÕES DE USO

Prepare a LifePort Kidney Transporter como descrito no Manual de Instruções da LifePort Kidney Transporter. Prepare o KPS-1®, Solução para Perfusão de Rins, de acordo com as Instruções de Uso. Manter o líquido de perfusão a uma temperatura apropriada, aproximadamente entre 2°C e 8°C.



ATENÇÃO: Quando indicado, realize o seguinte procedimento em ambiente asséptico, utilizando a técnica de assepsia apropriada.

1. *Utilizando técnicas de assepsia padronizadas*, prepare um campo estéril sobre uma mesa de trabalho e introduza todos os materiais necessários.
2. *Utilizando técnicas de assepsia padronizadas*, remova a Tampa Externa do Circuito de Perfusão e a Tampa Interna do Circuito de Perfusão e coloque sobre o campo estéril.
3. *Utilizando técnicas de assepsia padronizadas*, remova o Berço do Rim e coloque-o de lado, sobre o campo estéril.
4. *Utilizando técnicas de assepsia padronizadas*, encha o Circuito de Perfusão Descartável da LifePort Kidney Transporter com 1 litro de líquido de perfusão arrefecido (2°C e 8°C).
5. *Utilizando técnicas de assepsia padronizadas*, reponha e aperte a Tampa Interna do Circuito de Perfusão seguida da Tampa Externa do Circuito de Perfusão.



ATENÇÃO: As superfícies internas do Circuito de Perfusão Descartável da LifePort Kidney Transporter são consideradas estéreis, enquanto as superfícies externas não.

6. Coloque o Circuito de Perfusão Descartável da LifePort Kidney Transporter na LifePort Kidney Transporter.
7. Posicione a Estrutura de Tubulação na posição vertical, perpendicular à Plataforma da Bomba. Insira as dobradiças nos encaixes antes de alinhá-la com a Plataforma da Bomba.
8. Abra o Trilho do Cabeçote e prenda o Tubo de Fluxo da Bomba ao redor da Bomba de Infusão. Feche e trave o Trilho do Cabeçote.
9. Rode o Grampo de Travamento da Plataforma da Bomba em 90 graus, até que este encaixe com um clique.
10. Ligue o Cabo do Sensor de Pressão da Plataforma da Bomba ao Conector do Sensor de Pressão na Estrutura da Tubulação.



IMPORTANTE: Siga o procedimento descrito nas Instruções de Uso do Campo Cirúrgico Estéril Descartável da LifePort Kidney Transporter para manter as técnicas de assepsia padronizadas.



IMPORTANTE: Siga o procedimento descrito na Cânula Descartável da LifePort Kidney Transporter Instruções de Uso para canular e proteger o rim.

11. *Utilizando técnicas de assepsia padronizadas*, transfira o rim canulado do Berço do Rim para a LifePort Kidney Transporter, procedendo com cuidado para evitar tocar no Infusor.



IMPORTANTE: Para iniciar o processo de perfusão e verificar se há vazamentos, consulte o Manual de Instruções da LifePort Kidney Transporter.

12. *Utilizando técnicas de assepsia padronizadas*, reponha e aperte a Tampa Interna do Circuito de Perfusão.



IMPORTANTE: Siga os procedimentos nas Instruções de Uso do Campo Cirúrgico Estéril Descartável da LifePort Kidney Transporter para removê-lo da LifePort Kidney Transporter.

13. Reponha e aperte a Tampa Externa do Circuito de Perfusão.

 **IMPORTANTE:** Para prosseguir com o processo de perfusão, consulte o Manual de Instruções da LifePort Kidney Transporter.

Condições de Armazenamento: Armazenar entre 2°C e 40°C. Evitar calor e humidade excessivos. Manter em local seco e afastado da luz solar direta. Estéril desde que a embalagem não esteja aberta ou danificada.

Assistência Técnica: Contate a Organ Recovery Systems 24/7 Perfusion Helpline através dos telefones +1.866.682.4800 (ligação gratuita dentro dos EUA), +32.2.715.0005 (Bélgica), 0800.940.0057 (Brasil), +33.967.23.00.16 (França) ou +34.910.91.16.16 (Espanha).

Contraindicações: Não existem contraindicações conhecidas quando utilizado de acordo com as instruções.

IMPORTADOR NO BRASIL:

Emergo Brazil Import Importação e Distribuição de Produtos Médicos Hospitalares Ltda.
 Avenida Francisco Matarazzo, 1.752, Salas 502/503, Água Branca, São Paulo-SP, CEP: 05001-200
 CNPJ: 04.967.408/0001-98
 e-mail: BrazilVigilance@ul.com
 Registro ANVISA: 80117580126
 Responsável Técnico: Luiz Levy Cruz Martins CRF-SP: 42415

AVISOS E ALERTAS

 **AVISO:** A legislação federal norte-americana só permite a venda deste dispositivo a médicos ou com uma prescrição destes.

 **AVISO:** Os Produtos Descartáveis da LifePort Kidney Transporter devem ser armazenados em ambiente interior, num local seco e afastado da luz solar direta.















 **AVISO:** Verifique visualmente os Produtos Descartáveis da LifePort Kidney Transporter. Não utilize se as peças estiverem soltas, rachadas, quebradas ou se houver vazamento de líquido. Verifique se todas as conexões estão firmes antes da instalação.

 **AVISO:** Uso único. Não reutilize, reprocesse ou reesterilize. A reutilização, reprocessamento ou reesterilização de dispositivos destinados a uso único resultam em riscos potenciais para a saúde do paciente ou utilizador, podendo causar infeções por contaminação. Esta contaminação pode causar lesões, doenças ou outras complicações ao paciente.

 **ALERTA:** Utilize técnicas de assepsia padronizadas e medidas de precaução universais (ex.: luvas, máscaras, fatos cirúrgicos, óculos de proteção ou proteção equivalente para os olhos, sacos para lixo hospitalar) ao manusear o rim ou ao descartar os Produtos Descartáveis e o líquido de perfusão da LifePort Kidney Transporter, de modo a evitar a possível transmissão de agentes patogénicos para a equipa médica e os pacientes. Ao utilizar o aparelho sozinho, sem uma equipe, o médico em questão deverá prestar especial atenção para garantir as condições especificadas.

 **AVISO:** Antes do operador iniciar a aplicação do Campo Cirúrgico Estéril Descartável da LifePort Kidney Transporter, deverá remover a Tampa Externa do Circuito de Perfusão. A superfície exterior da Tampa Externa do Circuito de Perfusão não é considerada uma parte integrante do campo estéril. Utilize técnicas de assepsia padrão ao manusear a superfície interna do produto.

EXPLICAÇÃO DOS SÍMBOLOS

	Aviso/Atenção		Validade, AAAA-MM-DD		Limites de Temperatura
	Número do Lote		Data de Fabricação, AAAA-MM-DD		Consulte as Instruções de Uso
	Número de Referência		Fabricante		Manter Afastado da Luz Solar
	Não Reutilizar		Não Reesterilizar		Manter em Local Seco
	Aparelho Médico Esterilizado com Óxido de Etileno				Aparelho Médico Usado sob Prescrição

INDICACIONES DE USO

El sistema LifePort Kidney Transporter (LKT) se ha diseñado para la perfusión renal mecánica, continua e hipotérmica durante la conservación, el transporte y el eventual trasplante a un receptor.

DESCRIPCIÓN DEL DISPOSITIVO

El circuito de perfusión desechable del LifePort Kidney Transporter sirve para mantener el riñón y el perfundido en condiciones asépticas durante el transporte.

El sistema LifePort Kidney Transporter consta de los siguientes elementos:

- LifePort Kidney Transporter (LKT100P/LKT101P)
- Circuito de perfusión desechable del LifePort Kidney Transporter (LKT201)
- Paños estériles desechables del LifePort Kidney Transporter (LKT300)
- Cánula desechable del LifePort Kidney Transporter (CAN/UCAN)

INSTRUCCIONES DE USO

Prepare el LifePort Kidney Transporter siguiendo las indicaciones del manual del operario del LifePort Kidney Transporter. Prepare la solución de perfusión renal KPS-1® de acuerdo con las instrucciones de uso. Mantenga el perfusado a la temperatura correcta, que es de entre 2 y 8 °C.



ATENCIÓN: Cuando se indique, realice el procedimiento en un campo estéril y usando una técnica aséptica.

1. *Utilice la técnica aséptica de referencia* para preparar un campo estéril sobre la mesa de trabajo y colocar todo el material necesario.
2. *Utilice la técnica aséptica de referencia* para retirar las tapas exterior e interior del circuito de perfusión y colocarlas sobre el campo estéril.
3. *Utilice la técnica aséptica de referencia* para retirar el soporte del riñón y colocarlo sobre el campo estéril.
4. *Utilice la técnica aséptica de referencia* para llenar el circuito de perfusión del LifePort Kidney Transporter con 1 litro del perfusado en frío (2-8 °C).
5. *Utilice la técnica aséptica de referencia* para volver a colocar y fijar la tapa interior del circuito de perfusión y, a continuación, la tapa exterior del circuito de perfusión.



ATENCIÓN: Las superficies interiores del circuito de perfusión desechable del LifePort Kidney Transporter se consideran estériles, pero las superficies exteriores, no.

6. Introduzca el circuito de perfusión desechable del LifePort Kidney Transporter en el LifePort Kidney Transporter.
7. Coloque la estructura tubular en vertical, perpendicular al soporte de la bomba. Introduzca las bisagras en los receptores antes de hacerlas girar hacia el soporte de la bomba.
8. Abra el conducto del cabezal de la bomba y enrolle el circuito tubular de la bomba en torno a la bomba de infusión. Cierre y bloquee el conducto del cabezal de la bomba.
9. Haga girar el brazo de cierre del soporte de la bomba 90 grados hasta que oiga un chasquido.
10. Conecte el cable del sensor de presión de la cubierta de la bomba al conector del soporte de presión, situado en la estructura tubular.



NOTA: Siga el procedimiento que figura en las instrucciones de uso de los paños estériles desechables del LifePort Kidney Transporter para mantener las condiciones asépticas.



NOTA: Siga el procedimiento que figura en las instrucciones de uso de las cánulas desechables del LifePort Kidney Transporter para insertar y fijar la cánula en el riñón.

11. Tras la inserción de la cánula, *utilice la técnica aséptica de referencia* para transferir el riñón al soporte del riñón del LifePort Kidney Transporter y asegúrese de evitar el conducto de infusión.



NOTA: Siga las instrucciones que figuran en el manual del operario del LifePort Kidney Transporter para iniciar el proceso de perfusión y comprobar que no haya fugas.

12. *Utilice la técnica aséptica de referencia* para volver a colocar y fijar la tapa interior del circuito de perfusión.



NOTA: Siga el procedimiento que figura en las instrucciones de uso de los paños estériles desechables del LifePort Kidney Transporter para proceder a la extracción del LifePort Kidney Transporter.

13. Vuelva a colocar y cierre la tapa exterior del circuito de perfusión.

 **NOTA:** Siga las instrucciones que figuran en el manual del operario del LifePort Kidney Transporter para continuar con el proceso de perfusión.

Condiciones de almacenamiento: Almacene el dispositivo entre 2-40 °C. Evite el calor y la humedad excesivos. Mantenga el dispositivo en un lugar seco y alejado de la luz solar directa. Estéril, a menos que el envase esté dañado o abierto.

Asistencia técnica: Póngase en contacto con la línea de asistencia para la perfusión de Organ Recovery Systems, disponible las 24 horas del día, los 7 días de la semana, llamando al +1.866.682.4800 (número gratuito desde los EE. UU.), +32.2.715.0005 (Bélgica), 0800.940.0057 (Brasil), +33.967.23.00.16 (Francia) o 91.091.1616 (España).

Contraindicaciones: El dispositivo no presenta contraindicaciones, siempre que se use del modo indicado.

ADVERTENCIAS Y PRECAUCIONES

 **PRECAUCIÓN:** La legislación federal de los EE. UU. restringe la venta de este dispositivo a médicos o a quienes dispongan de la prescripción de un médico.

 **PRECAUCIÓN:** Los materiales fungibles del LifePort Kidney Transporter deben almacenarse en interiores, en un lugar seco y fuera de la luz solar directa.















 **ADVERTENCIA:** Revise de forma visual los materiales fungibles del LifePort Kidney Transporter. No los use si contienen piezas sueltas, agrietadas o rotas o si presentan fugas de líquidos. Antes de proceder con la instalación, asegúrese de que todas las conexiones estén apretadas.

 **ADVERTENCIA:** Monouso. No reutilice, vuelva a tratar ni reesterilice el dispositivo. Reutilizar, reprocesar o reesterilizar dispositivos de un solo uso genera un posible riesgo de contaminación cruzada para el paciente y el usuario. Dicha contaminación daría lugar a lesiones, enfermedades y otras complicaciones graves para el paciente.

 **ADVERTENCIA:** A la hora de manipular el riñón y de manipular y desechar los materiales fungibles del LifePort Kidney Transporter y el perfusato, use la técnica aséptica de referencia y ajústese a las precauciones básicas (p. ej., guantes, mascarillas, gafas o protectores oculares equivalentes y bolsas para material de riesgo biológico) para evitar una posible transmisión de patógenos a los pacientes y el personal clínico. Aquellos médicos que trabajen solos deberán prestar especial atención a dichas condiciones.

 **ADVERTENCIA:** Antes de usar los paños estériles desechables del LifePort Kidney Transporter, el usuario deberá retirar la tapa exterior del circuito de perfusión. La superficie exterior de la tapa del circuito de perfusión no se considera parte del campo estéril. Asegúrese de usar una técnica aséptica al manipular la superficie interior.

EXPLICACIÓN DE LOS SÍMBOLOS

	Advertencia/precaución		Usar antes del AAAA-MM-DD		Límites de temperatura
	Número de lote		Fecha de fabricación: AAAA-MM-DD		Consultar las instrucciones de uso
	Número de referencia		Fabricante		Mantener alejado de la luz solar
	No reutilizar		No reesterilizar		Mantener en un lugar seco
	Productos sanitarios esterilizados con óxido de etileno				Producto sanitario de venta con receta

INDICAZIONI D'USO

Il sistema LifePort Kidney Transporter (LKT) è destinato a essere utilizzato per la perfusione meccanica ipotermica continua di reni, per la conservazione, il trasporto e l'eventuale trapianto in un soggetto ricevente.

DESCRIZIONE DEL DISPOSITIVO

Il circuito di perfusione monouso di LifePort Kidney Transporter viene utilizzato per contenere il rene e il perfusato in condizioni asettiche durante il trasporto.

- Il sistema completo LifePort Kidney Transporter consiste dei seguenti componenti:
- LifePort Kidney Transporter (LKT100P/LKT101P)
- Circuito di perfusione monouso di LifePort Kidney Transporter (LKT201)
- Telo sterile monouso per LifePort Kidney Transporter (LKT300)
- Cannula monouso per LifePort Kidney Transporter (CAN/UCAN)

ISTRUZIONI PER L'USO

Preparare LifePort Kidney Transporter come illustrato nel relativo Manuale per l'Operatore. Preparare la soluzione per la perfusione renale KPS-1® in conformità alle Istruzioni per l'uso. Mantenere il perfusato alla temperatura adeguata, pari a circa 2-8 °C.



ATTENZIONE: dove indicato, eseguire la seguente procedura su campo asettico impiegando una tecnica asettica.

1. *Con tecnica asettica standard*, preparare un campo sterile su un piano di lavoro e disporvi tutti i materiali necessari.
2. *Con tecnica asettica standard*, rimuovere il coperchio del circuito di perfusione esterno e il coperchio del circuito di perfusione interno, e collocarli sul campo sterile.
3. *Con tecnica asettica standard*, rimuovere il cestello per rene e metterlo da parte sul campo sterile.
4. *Con tecnica asettica standard*, riempire il circuito di perfusione monouso di LifePort Kidney Transporter con un litro di perfusato refrigerato (2-8 °C).
5. *Con tecnica asettica standard*, riposizionare e bloccare il coperchio del circuito di perfusione interno seguito dal coperchio del circuito di perfusione esterno.



AVVERTENZA: le superfici interne del circuito di perfusione monouso di LifePort Kidney Transporter sono considerate sterili, al contrario delle superfici esterne.

6. Collocare il circuito di perfusione monouso di LifePort Kidney Transporter all'interno del LifePort Kidney Transporter.
7. Collocare il telaio per i tubi in posizione verticale, perpendicolare alla piastra della pompa. Inserire le cerniere nei rispettivi alloggi prima di ruotare il telaio in posizione orizzontale sulla piastra della pompa.
8. Aprire la canalina della testa della pompa e adattare l'ansa del tubo della pompa attorno alla pompa di infusione. Chiudere e bloccare la canalina della testa della pompa.
9. Ruotare il braccio di bloccaggio della piastra della pompa di 90 gradi finché scatta in posizione.
10. Collegare il cavo del sensore di pressione dalla piastra della pompa al connettore del sensore di pressione sul telaio per i tubi.



NOTA: seguire la procedura indicata nelle Istruzioni per l'uso del telo sterile monouso per LifePort Kidney Transporter per mantenere le condizioni di asepsi.



NOTA: seguire la procedura indicata nelle Istruzioni per l'uso della cannula monouso di LifePort Kidney Transporter per incannulare e fissare il rene.

11. *Con tecnica asettica standard*, trasferire il rene incannolato nel cestello per rene di LifePort Kidney Transporter, facendo attenzione a non agganciare la linea di infusione.



NOTA: seguire la procedura indicata nel manuale d'uso di LifePort Kidney Transporter per avviare il processo di perfusione e controllare per la presenza di eventuali perdite.

12. *Con tecnica asettica standard*, riposizionare e fissare il coperchio del circuito di perfusione interno.



NOTA: per la rimozione dal LifePort Kidney Transporter, seguire la procedura indicata nelle Istruzioni per l'uso del telo sterile monouso per LifePort Kidney Transporter.

13. Riposizionare e fissare il coperchio del circuito di perfusione esterno.



NOTA: seguire la procedura indicata nel manuale d'uso di LifePort Kidney Transporter per continuare il processo di perfusione.

Condizioni di conservazione: conservare tra i 2 °C e i 40 °C. Evitare condizioni di calore e umidità eccessivi. Conservare in luogo asciutto al riparo dalla luce solare diretta. Sterile a meno che la confezione sia danneggiata o aperta.

Assistenza tecnica: rivolgersi alla helpline per la perfusione di Organ Recovery Systems (attiva 24 ore su 24, 7 giorni su 7) ai numeri +1.866.682.4800 (numero verde negli USA), +32.2.715.0005 (Belgio), 0800.940.0057 (Brasile), +33.967.23.00.16 (Francia) o +34.910.91.16.16 (Spagna).

Controindicazioni: non sono note controindicazioni quando utilizzato come indicato.

MESSAGGI DI AVVERTENZA E ATTENZIONE

R_{Only} **ATTENZIONE:** le leggi federali degli Stati Uniti d'America limitano la vendita del presente dispositivo ai medici o su loro prescrizione.

 **ATTENZIONE:** i prodotti monouso LifePort Kidney Transporter devono essere conservati in ambienti chiusi, all'asciutto e al riparo dalla luce solare diretta.











 **AVVERTENZA:** ispezionare visivamente i prodotti monouso LifePort Kidney Transporter. Non utilizzare in presenza di componenti allentati, incrinati, rotti o in caso di perdita di liquido. Prima dell'installazione, verificare che tutti i raccordi siano serrati.

 **AVVERTENZA:** solo monouso. Non riutilizzare, ricondizionare o risterilizzare. Il riutilizzo, il ricondizionamento o la risterilizzazione dei dispositivi monouso comportano il rischio potenziale di infezione da contaminazione. Tale contaminazione può causare lesioni, patologie o altre gravi complicanze al paziente.

 **AVVERTENZA:** impiegare una tecnica asettica standard e precauzioni universali (ad es., guanti, mascherina, camici, occhiali protettivi o protezione per occhi equivalente, sacchetti per materiali a rischio biologico) quando si maneggia un rene e quando si maneggiano e smaltiscono prodotti monouso LifePort Kidney Transporter e il perfusato, per evitare il rischio di trasmissione di organismi patogeni al personale medico e ai pazienti. Il singolo operatore che lavora da solo deve prestare particolare attenzione al mantenimento di tali condizioni.

 **AVVERTENZA:** prima che l'operatore inizi ad applicare il telo sterile monouso per LifePort Kidney Transporter è necessario rimuovere il coperchio del circuito di perfusione esterno. Le superfici esterne del coperchio del circuito non sono considerate come facenti parte del campo sterile. Utilizzare una tecnica asettica quando si maneggia la superficie interna.

SPIEGAZIONE DEI SIMBOLI

	Avvertenza/Attenzione		Utilizzare entro il: AAAA-MM-GG		Limiti di temperatura
LOT	Numero di lotto		Data di produzione: AAAA-MM-GG		Consultare le Istruzioni per l'uso
REF	Numero di riferimento		Produttore		Tenere al riparo dalla luce solare
	Non riutilizzare		Non risterilizzare		Conservare in luogo asciutto
STERILE EO	Dispositivi medici sterilizzati con ossido di etilene			R_{Only}	Dispositivo medico soggetto a prescrizione

INDICATIONS

Le système LifePort Kidney Transporter (LKT) est destiné à être utilisé pour la perfusion mécanique en hypothermie continue de reins en vue de leur conservation, transport et transplantation éventuelle sur un receveur.

DESCRIPTION DE L'APPAREIL

Le circuit de perfusion à usage unique LifePort Kidney Transporter est utilisé pour maintenir le rein et le perfusé dans des conditions d'asepsie durant le transport.

Le système LifePort Kidney Transporter complet est composé des éléments suivants :

- LifePort Kidney Transporter (LKT100P/LKT101P)
- Circuit de perfusion à usage unique du LifePort Kidney Transporter (LKT201)
- Champ stérile à usage unique du LifePort Kidney Transporter (LKT300)
- Canule à usage unique du LifePort Kidney Transporter (CAN/UCAN)

MODE D'EMPLOI

Préparez le LifePort Kidney Transporter comme décrit dans le manuel d'utilisation. Préparez la solution de perfusion rénale KPS-1® selon le mode d'emploi. Maintenez le perfusé à la température appropriée, c'est-à-dire entre 2 et 8 °C.

 **MISE EN GARDE** : lorsque cela est indiqué, effectuez la procédure suivante dans une zone aseptique en utilisant une technique aseptique.

1. *En utilisant une technique aseptique standard*, préparez un champ stérile sur une table de travail et placez-y tout le matériel nécessaire.
2. *En utilisant une technique aseptique standard*, retirez le couvercle extérieur du circuit de perfusion, puis le couvercle intérieur du circuit de perfusion et placez-le sur le champ stérile.
3. *En utilisant une technique aseptique standard*, retirez le support pour greffon et mettez-le de côté sur le champ stérile.
4. *En utilisant une technique aseptique standard*, remplissez le circuit de perfusion à usage unique du LifePort Kidney Transporter avec un 1 litre de perfusé frais (2-8 °C).
5. *En utilisant une technique aseptique standard*, remettez et fixez le couvercle intérieur du circuit de perfusion, puis le couvercle extérieur du circuit de perfusion.

 **MISE EN GARDE** : les surfaces intérieures du circuit de perfusion à usage unique du LifePort Kidney Transporter sont considérées comme étant stériles, tandis que les surfaces extérieures ne sont pas considérées stériles.

6. Placez le circuit de perfusion à usage unique du LifePort Kidney Transporter dans le LifePort Kidney Transporter.
7. Positionnez le cadre de la tubulure à la verticale pour qu'il soit perpendiculaire à la plate-forme de la pompe. Insérez l'armature sur les charnières fixées sur la plate-forme avant de le rabattre sur la plate-forme de la pompe.
8. Ouvrez le passage de la tête de pompe et étirez la boucle de la tubulure pour la placer sur la pompe à perfusion. Fermez et verrouillez le passage de la tête de pompe.
9. Tournez le loquet de la plate-forme de la pompe à 90 degrés jusqu'à ce qu'il s'enclenche.
10. Branchez le câble du capteur de pression, de la plate-forme de la pompe sur le raccord du capteur de pression situé sur le cadre de la tubulure.

 **REMARQUE** : suivez la procédure indiquée dans le mode d'emploi du champ stérile à usage unique du LifePort Kidney Transporter pour maintenir les conditions d'asepsie.

 **REMARQUE** : suivez la procédure indiquée dans le mode d'emploi de la canule à usage unique du LifePort Kidney Transporter pour placer la canule et fixer le rein.

11. *En utilisant une technique aseptique standard*, transférez le rein canulé, placé dans son support, dans le LifePort Kidney Transporter, en veillant à ne pas accrocher la tubulure.

 **REMARQUE** : suivez la procédure indiquée dans le mode d'emploi du LifePort Kidney Transporter pour démarrer la perfusion et vérifier l'absence de fuites.

12. *En utilisant une technique aseptique standard*, remettez et fixez le couvercle intérieur du circuit de perfusion.

 **REMARQUE** : suivez la procédure indiquée dans le mode d'emploi du champ stérile à usage unique du LifePort Kidney Transporter pour le retirer du LifePort Kidney Transporter.

13. Remettez et fixez le couvercle extérieur du circuit de perfusion.

 **REMARQUE** : suivez la procédure indiquée dans le mode d'emploi du LifePort Kidney Transporter pour poursuivre la perfusion.

Conditions de stockage : conserver entre 2 et 40 °C. Éviter une chaleur et une humidité excessives. Conserver au sec et à l'abri de la lumière directe du soleil. Stérile à moins que l'emballage n'ait été endommagé ou ouvert.

Assistance technique : veuillez appeler la permanence téléphonique « Perfusion », 24 /24, 7 j/7, d'Organ Recovery Systems au +1.866.682.4800 (sans frais si vous résidez aux États-Unis), + 32.2.715.0005 (en Belgique), 0800.940.0057 (au Brésil), +33.967.23.00.16 (en France) ou au +34.910.91.16.16 (en Espagne).

Contre-indications : il n'existe aucune contre-indication connue lorsque l'appareil est utilisé comme indiqué.

AVERTISSEMENTS ET MISES EN GARDE

 **MISE EN GARDE** : la loi fédérale américaine (USA) n'autorise la vente de ce dispositif que par un médecin ou sur ordonnance médicale.

 **MISE EN GARDE** : les consommables du LifePort Kidney Transporter doivent être entreposés à l'intérieur, dans un endroit sec et à l'abri de la lumière directe du soleil.















 **AVERTISSEMENT** : vérifiez de visu les consommables du LifePort Kidney Transporter. Ne pas les utiliser si des pièces sont déconnectées, craquelées, cassées ou en cas de fuite de liquide. Vérifiez que tous les raccords sont bien serrés avant l'installation.

 **AVERTISSEMENT** : à usage unique. Ne pas réutiliser, retraiter ou stériliser. Réutiliser, retraiter ou restériliser un dispositif à usage unique entraîne un risque potentiel d'infection par contamination pour le patient ou l'utilisateur. Cette contamination peut occasionner des blessures, une maladie ou d'autres complications graves pour le patient.

 **AVERTISSEMENT** : lors de la manipulation du rein et de l'élimination des consommables du LifePort Kidney Transporter et du perfusat, utilisez une technique aseptique standard et des précautions universelles (p. ex. port de gants, masques, lunettes ou protection oculaire équivalente, utilisation de sacs pour déchets biologiques) afin d'éviter une transmission possible des pathogènes au personnel médical ou aux patients. Tout praticien travaillant seul doit accorder une attention particulière à ces conditions.

 **AVERTISSEMENT** : le couvercle extérieur du circuit de perfusion doit être enlevé avant que l'opérateur ne commence à appliquer le champ stérile à usage unique du LifePort Kidney Transporter. Les surfaces extérieures du couvercle du circuit de perfusion ne sont pas considérées comme faisant partie de la zone stérile. Utilisez une technique aseptique standard lorsque vous manipulez la surface intérieure.

EXPLICATION DES SYMBOLES

	Avertissement/Mise en garde		Utiliser avant : AAAA-MM-JJ		Limites de température
	Numéro de lot		Date de fabrication : AAAA-MM-JJ		Consulter le mode d'emploi
	Numéro de référence		Fabricant		Tenir à l'abri de la lumière du soleil
	Ne pas réutiliser		Ne pas restériliser		Conserver au sec
	Dispositifs médicaux stériles utilisant de l'oxyde d'éthylène				Dispositif médical soumis à ordonnance médicale

INDICATIES VOOR GEBRUIK

Het LifePort Kidney Transporter-systeem (LKT-systeem) is bedoeld voor de continue, hypothermische machinale perfusie van nieren voor het conserveren, het vervoer en de uiteindelijke transplantatie bij een ontvanger.

OMSCHRIJVING VAN HET HULPMIDDEL

Het wegwerpbare LifePort Kidney Transporter-perfusiecircuut wordt gebruikt voor de opslag van de nier en het onder aseptische omstandigheden perfuseren van de nier tijdens het vervoer.

Het volledige LifePort Kidney Transporter-systeem bestaat uit de volgende onderdelen:

- LifePort Kidney Transporter (LKT100P/LKT101P)
- Wegwerpbaar LifePort Kidney Transporter-perfusiecircuut (LKT201)
- Steriele afdekking voor LifePort Kidney Transporter (LKT300)
- Wegwerpbare canule van LifePort Kidney Transporter (CAN/UCAN)

INSTRUCTIES VOOR GEBRUIK

Bereid de LifePort Kidney Transporter voor zoals beschreven in de gebruikershandleiding van de LifePort Kidney Transporter. Bereid de nierperfusieoplossing KPS-1® volgens de instructies voor gebruik. Zorg ervoor dat de perfusieoplossing op de juiste temperatuur (ongeveer 2-8 °C) blijft.

 **LET OP:** voer, wanneer dit wordt aangegeven, de volgende procedure uit op een aseptisch veld met behulp van een aseptische techniek.

1. *Bereid aan de hand van de standaard aseptische techniek* een steriel veld voor op een werktafel en leg alle benodigde materialen klaar op dit vlak.
2. *Verwijder aan de hand van de standaard aseptische techniek* het buiten- en binnendeksel van het perfusiecircuut en plaats deze in het steriele veld.
3. *Verwijder de nierhouder aan de hand van de standaard aseptische techniek* en zet deze opzij binnen het steriele veld.
4. Vul het wegwerpbare perfusiecircuut LifePort Kidney Transporter met 1 liter gekoelde (2-8 °C) perfusieoplossing aan de hand van de *standaard aseptische techniek*.
5. Plaats het binnendeksel van het perfusiecircuut terug en zet deze vast, gevolgd door het buitendeksel van het perfusiecircuut, en maak hierbij gebruik van een *standaard aseptische techniek*.

 **LET OP:** de binnenzijde van het wegwerpbare perfusiecircuut LifePort Kidney Transporter wordt als steriel beschouwd, terwijl dit niet geldt voor de buitenkant.

6. Plaats het wegwerpbare perfusiecircuut in de LifePort Kidney Transporter.
7. Zet het frame met de slangen rechtop, loodrecht op het pompdek. Breng de scharnieren aan in de houders voordat u het frame plat op het pompdek draait.
8. Open het kanaal van de pompkop en draai de pompslanglus om de infusiepomp. Sluit en vergrendel het kanaal van de pompkop.
9. Draai de vergrendelarm van het pompdek 90 graden totdat deze op zijn plaats klikt.
10. Sluit de druksensorkabel van het pompdek aan op de druksensoraansluiting op het frame met de slangen.

 **OPMERKING:** volg de procedure die wordt beschreven in de instructies voor gebruik van de wegwerpbare steriele afdekking van de LifePort Kidney Transporter om ervoor te zorgen dat de aseptische omstandigheden blijven behouden.

 **OPMERKING:** volg de procedure uit de instructies voor gebruik van de wegwerpbare canule van de LifePort Kidney Transporter om de nier te canuleren en vast te zetten.

11. Breng met behulp van een standaard aseptische techniek de gecanuleerde nier in de nierhouder over naar de LifePort Kidney Transporter en let er daarbij op dat de infusieslang nergens achter blijft haken.

 **OPMERKING:** volg de procedure in de gebruikershandleiding van de LifePort Kidney Transporter om het perfusieproces te starten en te controleren op lekken.

12. Plaats het binnendeksel van het perfusiecircuut terug en zet deze vast met gebruik van een standaard aseptische techniek.

 **OPMERKING:** volg de procedure in de instructies voor gebruik van de wegwerpbare steriele afdekking van de LifePort Kidney Transporter voor het verwijderen van de afdekking van de LifePort Kidney Transporter.

13. Plaats het buitendeksel van het perfusiecircuut terug en zet deze vast.

 **OPMERKING:** volg de procedure in de gebruikershandleiding van de LifePort Kidney Transporter om het perfusieproces voort te zetten.

Opslagomstandigheden: bewaren tussen 2 °C en 40 °C. Vermijd overmatige hitte en vochtigheid. Droog en uit de buurt van direct zonlicht bewaren. Steriel tenzij de verpakking is beschadigd of geopend.

Technische ondersteuning: neem contact op met de 24/7-perfusiehelpline van Organ Recovery Systems op +1.866.682.4800 (gratis in de VS), +32.2.715.0005 (België), 0800.940.0057 (Brazilië), +33.967.23.00.16 (Frankrijk) of +34.910.91.16.16 (Spanje).

Contra-indicaties: er zijn geen contra-indicaties bekend indien dit hulpmiddel zoals omschreven wordt gebruikt.

WAARSCHUWINGEN EN OPMERKINGEN

 **LET OP:** volgens de Amerikaanse wetgeving is verkoop van dit hulpmiddel uitsluitend toegestaan door of op voorschrift van een arts.

 **LET OP:** de wegwerpbare producten van de LifePort Kidney Transporter moeten binnenshuis op een droge plek worden bewaard zonder blootstelling aan direct zonlicht.















 **WAARSCHUWING:** controleer de wegwerpbare producten van de LifePort Kidney Transporter visueel. Gebruik de producten niet wanneer onderdelen loszitten, gebarsten of kapot zijn of als er vloeistof uit lekt. Controleer vóór installatie of alle aansluitingen goed vastzitten.

 **WAARSCHUWING:** uitsluitend bedoeld voor eenmalig gebruik. Niet opnieuw gebruiken, herverwerken of hersteriliseren. Door hergebruik, herverwerking of hersterilisatie van hulpmiddelen die zijn bedoeld voor eenmalig gebruik ontstaat er een potentieel risico op infecties bij de patiënt of gebruiker vanwege besmetting. Deze besmetting kan leiden tot letsel, ziekte of andere ernstige complicaties bij de patiënt.

 **WAARSCHUWING:** maak gebruik van een standaard aseptische techniek en universele voorzorgsmaatregelen (zoals het dragen van handschoenen, een masker, een jas, een bril of vergelijkbare oogbescherming en het gebruiken van zakken voor biologisch gevaarlijk afval) bij het hanteren van de nier en bij het hanteren en afvoeren van de wegwerpbare producten van de LifePort Kidney Transporter en de perfusieoplossing om de mogelijke overdracht van pathogenen aan medisch personeel en patiënten te voorkomen. Indien een arts alleen werkt, moet hij/zij er speciaal op toezien deze omstandigheden te handhaven.

 **WAARSCHUWING:** voordat de gebruiker de wegwerpbare steriele afdekking van de LifePort Kidney Transporter aanbrengt, moet het buitendeksel van het perfusiecircuït worden verwijderd. De buitenzijde van het deksel van het perfusiecircuït wordt niet als deel van een steriel veld beschouwd. Gebruik een standaard steriele techniek bij het aanraken van de binnenzijde.

UITLEG VAN DE SYMBOLEN

	Waarschuwing/opmerking		Gebruiken vóór: JJJJ-MM-DD		Temperatuurgrenzen
	Lotnummer		Fabricagedatum: JJJJ-MM-DD		Raadpleeg de instructies voor gebruik
	Referentienummer		Fabrikant		Uit de buurt van zonlicht houden
	Niet opnieuw gebruiken		Niet opnieuw steriliseren		Droog houden
	Medische hulpmiddelen gesteriliseerd met ethyleenoxide				Medisch hulpmiddel op voorschrift

VERWENDUNGSZWECK

Der LifePort Kidney Transporter (LKT) ist eine Transportbox zur kontinuierlichen hypothermischen Maschinenperfusion von Spendernieren, in der die Nieren bis zur Transplantation beim Empfänger konserviert und transportiert werden können.

GERÄTEBESCHREIBUNG

Der Einweg-Perfusionskreislauf des LifePort Kidney Transporter dient dazu, die Niere und das Perfusat während des Transports unter aseptischen Bedingungen aufzubewahren.

Der LifePort Kidney Transporter besteht im Einzelnen aus folgenden Komponenten:

- LifePort Kidney Transporter (LKT100P/LKT101P)
- Einweg-Perfusionskreislauf für LifePort Kidney Transporter (LKT201)
- Steriles Einweg-Tuch für LifePort Kidney Transporter (LKT300)
- Einweg-Kanüle für LifePort Kidney Transporter (CAN/UCAN)

GEBRAUCHSANWEISUNG

Den LifePort Kidney Transporter gemäß der Bedienungsanleitung des LifePort Kidney Transporter vorbereiten. Die Nierenperfusionslösung KPS-1® in Übereinstimmung mit der Gebrauchsanweisung vorbereiten. Das Perfusat bei einer geeigneten Temperatur, ca. 2 bis 8 °C, halten.



VORSICHT: Sofern angegeben, das folgende Verfahren in einem aseptischen Bereich und unter Anwendung einer aseptischen Methode durchführen.

1. *Mittels einer standardmäßigen aseptischen Methode* einen Sterilbereich auf einem Arbeitstisch vorbereiten und alle erforderlichen Materialien bereithalten.
2. *Mittels einer standardmäßigen aseptischen Methode* den Deckel des äußeren Perfusionskreislaufs sowie den Deckel des inneren Perfusionskreislaufs entfernen und im Sterilbereich ablegen.
3. *Mittels einer standardmäßigen aseptischen Methode* die Nierenkassette entnehmen und im Sterilbereich ablegen.
4. *Mittels einer standardmäßigen aseptischen Methode* den Einweg-Perfusionskreislauf für den LifePort Kidney Transporter mit 1 Liter gekühltem (2 bis 8 °C) Perfusat befüllen.
5. *Mittels einer standardmäßigen aseptischen Methode* den Deckel des inneren Perfusionskreislaufs und anschließend den Deckel des äußeren Perfusionskreislaufs wieder aufstecken und sichern.



VORSICHT: Die inneren Oberflächen des Einweg-Perfusionskreislaufs für den LifePort Kidney Transporter gelten als steril, während die äußeren Oberflächen als nicht steril gelten.

6. Den Einweg-Perfusionskreislauf für den LifePort Kidney Transporter in den LifePort Kidney Transporter legen.
7. Den Schlauchrahmen aufrecht sowie rechtwinklig zum Pumpendeck positionieren. Die Scharniere in die Aufnahmen stecken, anschließend den Schlauchrahmen flach auf das Pumpendeck drehen.
8. Den Leitungskanal des Pumpenkopfes öffnen und die Pumpenschlauchschleife um die Infusionspumpe ziehen. Den Leitungskanal des Pumpenkopfes schließen und verriegeln.
9. Den Verriegelungsarm des Pumpendecks um 90 Grad drehen, bis er hörbar einrastet.
10. Das Drucksensorkabel vom Pumpendeck am Drucksensor-Steckverbinder, der sich am Schlauchrahmen befindet, anschließen.



HINWEIS: Zur Sicherstellung aseptischer Bedingungen sind die in der Gebrauchsanweisung für das sterile Einweg-Tuch für den LifePort Kidney Transporter enthaltenen Verfahrensschritte zu befolgen.



HINWEIS: Zur Kanülierung und zum Schutz der Niere sind die in der Gebrauchsanweisung für die Einweg-Kanüle für den LifePort Kidney Transporter enthaltenen Verfahrensschritte zu befolgen.

11. *Mittels einer standardmäßigen aseptischen Methode* die kanülierte Niere in die Nierenkassette des LifePort Kidney Transporter einbringen, dabei besonders darauf achten, dass der Infusionsschlauch nicht berührt wird.



HINWEIS: Für den Beginn des Perfusionsprozesses und zur Prüfung auf Leckagen sind die in der Bedienungsanleitung des LifePort Kidney Transporter enthaltenen Verfahrensschritte zu befolgen.

12. *Mittels einer standardmäßigen aseptischen Methode* den Deckel des inneren Perfusionskreislaufs wieder aufstecken und sichern.



HINWEIS: Für das Entfernen vom LifePort Kidney Transporter sind die in der Gebrauchsanweisung für das sterile Einweg-Tuch für den LifePort Kidney Transporter enthaltenen Verfahrensschritte zu befolgen.

13. Den Deckel des äußeren Perfusionskreislaufs wieder aufstecken und sichern.

 **HINWEIS:** Für die Weiterführung des Perfusionsprozesses sind die in der Bedienungsanleitung des LifePort Kidney Transporter enthaltenen Verfahrensschritte zu befolgen.

Lagerbedingungen: Bei einer Umgebungstemperatur von 2 bis 40 °C lagern. Übermäßige Hitze und Luftfeuchtigkeit vermeiden. Trocken lagern und vor direkter Sonneneinstrahlung schützen. Das Produkt ist steril, solange die Verpackung nicht geöffnet oder beschädigt wurde.

Technischer Support: Wenden Sie sich bitte an die rund um die Uhr verfügbare Perfusions-Hotline von Organ Recovery Systems, unter +1.866.682.4800 (gebührenfrei in den USA), +32.2.715.0005 (Belgien), 0800.940.0057 (Brasilien), +33.967.23.00.16 (Frankreich) oder +34.910.91.16.16 (Spanien).

Kontraindikationen: Bei einer Verwendung laut den Anweisungen sind keine Kontraindikationen bekannt.

WARNUNGEN UND VORSICHTSMASSNAHMEN

 **VORSICHT:** Gemäß der Bundesgesetzgebung der USA darf dieses Produkt nur an Ärzte oder auf deren Anweisung verkauft werden.

 **VORSICHT:** Verbrauchsmaterialien für den LifePort Kidney Transporter sollten in Innenräumen, trocken und vor direkter Sonneneinstrahlung geschützt gelagert werden.















 **WARNUNG:** Die Verbrauchsmaterialien für den LifePort Kidney Transporter sind einer Sichtprüfung zu unterziehen. Keine Teile verwenden, die locker, rissig oder gebrochen sind oder aus denen Flüssigkeit austritt. Vor der Installation prüfen, ob alle Anschlussstücke fest sind.

 **WARNUNG:** Nur für den Einmalgebrauch. Nicht wiederverwenden, wiederaufbereiten oder resterilisieren. Eine Wiederverwendung, Wiederaufbereitung oder Resterilisation kann zu Infektionen des Patienten oder Anwenders aufgrund einer Kontamination führen. Diese Kontamination kann zu Verletzungen, Erkrankungen oder ernsthaften Komplikationen bei Patienten führen.

 **WARNUNG:** Beim Umgang mit der Niere sowie beim Umgang mit und der Entsorgung von Verbrauchsmaterialien für den LifePort Kidney Transporter und von Perfusat eine standardmäßige aseptische Methode und allgemeingültige Vorsichtsmaßnahmen (z. B. Schutzhandschuhe, Schutzmasken, Kittel, Schutzbrillen oder ein gleichwertiger Augenschutz, Beutel für Sterilgut, das eine biologische Gefährdung darstellen könnte) anwenden, um eine mögliche Übertragung von Krankheitserregern auf die medizinischen Fachkräfte und die Patienten zu verhindern. Ärzte, die allein arbeiten, sind besonders angehalten, auf die Einhaltung dieser Bedingungen zu achten.

 **WARNUNG:** Vor Verwendung des sterilen Einweg-Tuches für den LifePort Kidney Transporter durch den Anwender sollte der Deckel des äußeren Perfusionskreislaufs entfernt werden. Die äußeren Oberflächen des Deckels des äußeren Perfusionskreislaufs gelten nicht als steril. Mittels einer standardmäßigen aseptischen Methode die inneren Oberflächen behandeln.

ERKLÄRUNG DER SYMBOLE

	Warnung/Vorsicht		Zu verwenden bis JJJJ-MM-TT		Temperaturbeschränkungen
	Chargennummer		Herstellungsdatum, JJJJ-MM-TT		Gebrauchsanweisung beachten
	Referenznummer		Hersteller		Vor direkter Sonneneinstrahlung schützen
	Nicht wiederverwenden		Nicht resterilisieren		Trocken halten
	Sterile Medizinprodukte, die mit Ethylenoxid arbeiten			Verschreibungspflichtiges Medizinprodukt	

INDIKATIONER

LifePort njurtransportörsystem (LKT, LifePort Kidney Transporter) är avsett att användas för kontinuerlig hypoterm maskinperfusion av njurar för preservation, transport och slutligen transplantation till en mottagare.

BESKRIVNING AV PRODUKTEN

LifePort engångsperfusionskrets för njurtransportör används för att under aseptiska förhållanden förvara och perfundera njuren under transport.

Det fullständiga LifePort njurtransportörsystemet består av följande delar:

- LifePort njurtransportör (LKT100P/LKT101P)
- LifePort engångsperfusionskrets för njurtransportör (LKT201)
- LifePort steril engångsduk för njurtransportör (LKT300)
- LifePort engångskanyl för njurtransportör (CAN/UCAN)

BRUKSANVISNING

Förbered LifePort njurtransportör enligt beskrivningen i användarhandboken till LifePort njurtransportör. Förbered KPS-1[®], perfusionslösning för njure, enligt bruksanvisningen. Håll perfusionslösningen på en lämplig temperatur, cirka 2-8 °C.



FÖRSIKTIGHET! Där så anges ska följande procedur utföras i ett aseptiskt fält med användning av aseptisk teknik.

1. *Gör med användning av aseptisk teknik* iordning ett sterilt fält på ett arbetsbord och för in allt nödvändigt material.
2. *Med användning av sedvanlig aseptisk teknik*, ta av det yttre och det inre perfusionskretslocket och lägg dem i det sterila fältet.
3. *Med användning av sedvanlig aseptisk teknik*, ta ut njurvaggan och sätt den åt sidan i det sterila fältet.
4. *Med användning av sedvanlig aseptisk teknik*, fyll LifePort engångsperfusionskrets för njurtransportör med 1 liter kylid (2-8 °C) perfusionslösning.
5. *Med användning av sedvanlig aseptisk teknik*, sätt tillbaka och säkra det inre perfusionskretslocket och sedan det yttre perfusionskretslocket.



FÖRSIKTIGHET! De inre ytorna på LifePort engångsperfusionskrets för njurtransportör betraktas som sterila, och de utvändiga ytorna som osterila.

6. Placera LifePort engångsperfusionskrets för njurtransportör i LifePort njurtransportör.
7. Positionera slangramen så att den står upprätt, vinkelrätt mot pumpdäcket. Sätt i gångjärnen i mottagarna innan enheten vrids platt mot pumpdäcket.
8. Öppna pumphuvudet och sträck pumpslangsslyngan runt infusionspumpen. Stäng och spärra pumphuvudet.
9. Vrid pumpdäckets låsarm 90 grader tills den klickar på plats.
10. Anslut trycksensorkabeln från pumpdäcket till trycksensorkontakten på rörramen.



OBS! Följ proceduren som beskrivs i bruksanvisningen till LifePort steril engångsduk för njurtransportör så att aseptiska förhållanden upprätthålls.



OBS! Följ proceduren som beskrivs i bruksanvisningen till LifePort engångskanyl för njurtransportör för att kanylera och säkra njuren.

11. *Med användning av sedvanlig aseptisk teknik*, överför den kanylerade njuren i njurvaggan till LifePort njurtransportör och var försiktig så att infusionsslangen inte kommer i kläm.



OBS! Följ proceduren i användarhandboken till LifePort njurtransportör för att starta perfusionen och se efter läckage.

12. *Med användning av sedvanlig aseptisk teknik*, sätt tillbaka och säkra det inre perfusionskretslocket.



OBS! Följ proceduren i bruksanvisningen till LifePort steril engångsduk för njurtransportör för uttagning ur LifePort njurtransportör.

13. Sätt tillbaka och säkra det yttre perfusionskretslocket.



OBS! Följ proceduren i användarhandboken till LifePort njurtransportör för att fortsätta med perfusionsproceduren.

Förvaring: Förvaras mellan 2 och 40 °C. Undvik kraftig värme och luftfuktighet. Ska förvaras torrt och skyddad från direkt solsken. Steril under förutsättning att förpackningen inte är skadad eller öppnad.

Teknisk hjälp: Kontakta Organ Recovery Systems perfusionshjälp, öppen dygnet runt, på +1.866.682.4800 (avgiftsfritt inom USA), +32.2.715.0005 (Belgien), 0800.940.0057 (Brasilien), +33.967.23.00.16 (Frankrike) eller +34.910.91.16.16 (Spanien).

Kontraindikationer: Det finns inga kända kontraindikationer vid användning enligt anvisningarna.

VARNINGAR OCH FÖRSIKTIGHETSBEAKTANDEN

R_{Only} **OBS!** Enligt federal lag (USA) får denna enhet endast säljas av eller på order av en läkare.

 **FÖRSIKTIGHET!** LifePort engångsprodukter till njurtransportör ska förvaras inomhus på en torr plats skyddad mot direkt solsken.











 **WARNING!** Inspektera LifePort engångsprodukter till njurtransportör visuellt. Använd inte en produkt som uppvisar lösa, spruckna eller trasiga delar eller vätskeläckage. Kontrollera att alla fattningar är täta före installation.

 **WARNING!** Endast för engångsbruk. Får ej återanvändas, rengöras för återanvändning eller resteriliseras. Återanvändning, rengöring för återanvändning eller resterilisering av engångsprodukter kan utsätta patienten och användaren för risker på grund av kontaminering. Sådan kontaminering kan leda till skador, sjukdom eller andra allvarliga patientkomplikationer.

 **WARNING!** Använd sedvanlig aseptisk teknik och universella försiktighetsåtgärder (t.ex. handskar, munskydd, rock, skyddsglasögon eller motsvarande ögonskydd, påsar för smittförande material) vid hantering av njuren och vid hantering och bortskaffning av LifePort engångsprodukter och perfusionslösning till njurtransportör för att förhindra möjlig överföring av patogener till sjukvårdspersonal och patienter. En sjukvårdspersonal som arbetar ensam måste vara särskilt uppmärksam på att dessa förhållanden upprätthålls.

 **WARNING!** Innan användaren lägger på LifePort steril engångsduk för njurtransportör måste det yttre perfusionskretslocket vara avtaget. Utsidan av det yttre perfusionskretslocket anses inte utgöra del av ett sterilt fält. Använd sedvanlig aseptisk teknik vid hantering av den inre ytan.

SYMBOLFÖRKLARING

	Varning/Försiktighet		Använd före, AAAA-MM-DD		Temperaturgränser
LOT	Partinummer		Tillverkningsdatum, AAAA-MM-DD		Se bruksanvisningen
REF	Referensnummer		Tillverkare		Skyddas mot solsken
	Får ej återanvändas		Får ej resteriliseras		Förvaras torrt
STERILEEO	Sterila medicinska enheter steriliserade med etylenoxid		R_{Only}	Receptbelagd medicinsk enhet	

© 2019 Organ Recovery Systems, Inc.
Made and printed in the USA.

This page intentionally left blank.

Esta página se ha dejado en blanco a propósito.

Denna sida har avsiktligen lämnats blank.

Deze pagina is met opzet blanco gelaten.

Diese Seite wurde absichtlich leer gelassen.

Page intentionnellement laissée vide.

Questa pagina è stata lasciata intenzionalmente in bianco.

Página intencionalmente deixada em branco.

This page intentionally left blank.

Esta página se ha dejado en blanco a propósito.

Denna sida har avsiktligen lämnats blank.

Deze pagina is met opzet blanco gelaten.

Diese Seite wurde absichtlich leer gelassen.

Page intentionnellement laissée vide.

Questa pagina è stata lasciata intenzionalmente in bianco.

Página intencionalmente deixada em branco.

This page intentionally left blank.

Esta página se ha dejado en blanco a propósito.

Denna sida har avsiktligen lämnats blank.

Deze pagina is met opzet blanco gelaten.

Diese Seite wurde absichtlich leer gelassen.

Page intentionnellement laissée vide.

Questa pagina è stata lasciata intenzionalmente in bianco.

Página intencionalmente deixada em branco.

This page intentionally left blank.

Esta página se ha dejado en blanco a propósito.

Denna sida har avsiktligen lämnats blank.

Deze pagina is met opzet blanco gelaten.

Diese Seite wurde absichtlich leer gelassen.

Page intentionnellement laissée vide.

Questa pagina è stata lasciata intenzionalmente in bianco.

Página intencionalmente deixada em branco.

This page intentionally left blank.

Esta página se ha dejado en blanco a propósito.

Denna sida har avsiktligen lämnats blank.

Deze pagina is met opzet blanco gelaten.

Diese Seite wurde absichtlich leer gelassen.

Page intentionnellement laissée vide.

Questa pagina è stata lasciata intenzionalmente in bianco.

Página intencionalmente deixada em branco.

This page intentionally left blank.

Esta página se ha dejado en blanco a propósito.

Denna sida har avsiktligen lämnats blank.

Deze pagina is met opzet blanco gelaten.

Diese Seite wurde absichtlich leer gelassen.

Page intentionnellement laissée vide.

Questa pagina è stata lasciata intenzionalmente in bianco.

Página intencionalmente deixada em branco.